



5 3 3 3

2-tråds programmerbar
transmitter

Nr. 5333V111-DK

Fra serienr.:

132094001 - 132094630

141115001 →



Revision Notes

The following list provides notes concerning revisions of this document.

Rev. ID	Date	Notes
111	13/45	IECEX and INMETRO approvals added

2-TRÅDS PROGRAMMERBAR TRANSMITTER

PRetop 5333

Indholdsfortegnelse

Anvendelse.....	2
Teknisk karakteristik	2
Montage / installation.....	2
Applikationer	3
Bestillingsskema: 5333.....	4
Elektriske specifikationer	4
Tilslutninger.....	7
Blokdiagram	8
Programmering	9
Mekaniske specifikationer.....	10
Montering af følerledninger	10
Appendix	11
ATEX Installation Drawing - 5333A	12
ATEX Installation Drawing - 5333D	13
IECEx Installation Drawing - 5333A.....	15
IECEx Installation Drawing - 5333D.....	16
FM Installation Drawing - 5333D.....	18
CSA Installation Drawing - 5333D	20
INMETRO Instruções de Segurança - 5333A.....	21
INMETRO Instruções de Segurança - 5333D.....	22

2-TRÅDS PROGRAMMERBAR TRANSMITTER PRetop 5333

- *Indgang for RTD eller Ohm*
- *Høj målenøjagtighed*
- *3-leder tilslutning*
- *Programmerbar følerfejlsværdi*
- *Kan monteres i DIN form B følerhoved*

Anvendelse

- Temperaturlineariseret måling med Pt100...Pt1000 eller Ni100...Ni1000 føler.
- Omsætning af lineær modstandsændring til standard analogt strømsignal, f.eks. fra ventiler eller ohmske niveaustave.

Teknisk karakteristik

- PR5333 kan af brugeren i løbet af få sekunder programmeres til at måle inden for alle normerede RTD-temperaturområder.
- RTD- og modstandsindgangen har kabelkompensering for 3-leder tilslutning.

Montage / installation

- Kan monteres i DIN form B følerhoved. I ikke-eksplosionsfarlige områder kan 5333 monteres på en DIN-skinne med et specielt beslag.
- **NB:** Som Ex-barriere for 5333D anbefaler vi 5104B, 5114B eller 5116B.

APPLIKATIONER

RTD til 4...20 mA

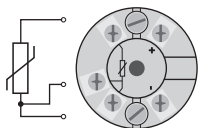

2-trådsinstallation
i kontrolrum

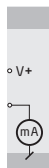

Modstand til 4...20 mA

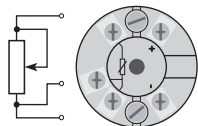

2-trådsinstallation
i kontrolrum

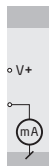

Bestillingsskema: 5333

Type	Version
5333	Standard : A CSA, FM, ATEX, IECEx & INMETRO : D

Elektriske specifikationer

Specifikationsområde:

-40°C til +85°C

Fælles specifikationer:

Forsyningsspænding DC

Standard.....	8...35 V
CSA, FM, ATEX, IECEx & INMETRO.....	8...30 V
Egetforbrug.....	25 mW...0,8 W
Spændingsdrop.....	8 VDC
Opvarmningstid.....	5 min.
Kommunikationsinterface.....	Loop Link
Signal- / støjforhold.....	Min. 60 dB
Reaktionstid (programmerbar).....	0,33...60 s
Signaldynamik, indgang.....	19 bit
Signaldynamik, udgang.....	16 bit
Kalibreringstemperatur.....	20...28°C

Nøjagtighed, størst af generelle og basisværdier:

Generelle værdier		
Indgangstype	Absolut nøjagtighed	Temperaturkoefficient
Alle	$\leq \pm 0,1\%$ af span	$\leq \pm 0,01\%$ af span / °C

Basisværdier		
Indgangstype	Basisnøjagtighed	Temperaturkoefficient
RTD	$\leq \pm 0,3^\circ\text{C}$	$\leq \pm 0,01^\circ\text{C}/^\circ\text{C}$
Lin. R	$\leq \pm 0,2 \Omega$	$\leq \pm 20 \text{ m}\Omega / ^\circ\text{C}$

EMC-immunitetspåvirkning.....	$< \pm 0,5\%$ af span
-------------------------------	-----------------------

Virkning af forsyningsspændingsændring	≤ 0,005% af span / VDC
Vibration	IEC 60068-2-6 Test FC
2...25 Hz	±1,6 mm
25...100 Hz	±4 g
Max. ledningskvadrat	1 x 1,5 mm ² flerkeret ledning
Luftfugtighed	< 95% RH (ikke kond.)
Mål	Ø 44 x 20,2 mm
Kapslingsklasse (hus / klemme)	IP68 / IP00
Vægt	50 g

Elektriske specifikationer indgang:

RTD- og lineær modstandsindgang:

RTD-type	Min. værdi	Max. værdi	Min. span	Standard
Pt100	-200°C	+850°C	25°C	IEC 60751
Ni100	-60°C	+250°C	25°C	DIN 43760
Lin. R	0 Ω	10000 Ω	30 Ω	-----

Max. nulpunktsforskydning (offset)..... 50% af valgt max. værdi

Kabelmodstand pr. leder (max.)..... 10 Ω

Følerstrøm..... > 0,2 mA, < 0,4 mA

Virkning af følerkabelmodstand

(3-leder)..... < 0,002 Ω / Ω

Følerfejlsdetektering..... Ja

Udgang:

Strømodgang:

Signalområde..... 4...20 mA

Min. signalområde..... 16 mA

Opdateringstid..... 135 ms

Belastningsmodstand..... ≤ (Vforsyn- 8) / 0,023 [Ω]

Belastningsstabilitet..... < ±0,01% af span / 100 Ω

Følerfejlsdetektering:

Programmerbar..... 3,5...23 mA

NAMUR NE43 Upscale..... 23 mA

NAMUR NE43 Downscale..... 3,5 mA

Af span = Af det aktuelt valgte område

Godkendelser:

EMC 2004/108/EF EN 61326-1

GOST R

Marinegodkendelse:

Det Norske Veritas, Ships & Offshore Stand. f. Certific. No. 2.4

Ex / I.S.:

ATEX 94/9/EF

5333A..... KEMA 10ATEX0003 X

5333D..... KEMA 03ATEX1535 X

FM 2D5A7

CSA..... 1125003

IECEX..... DEK 13.0036 X

INMETRO DEKRA 13.0002 X

GOST Ex

TILSLUTNINGER

Indgang:

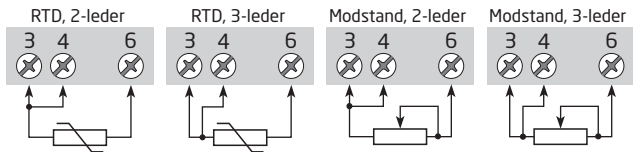

Udgang:

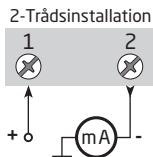

BLOKDIAGRAM

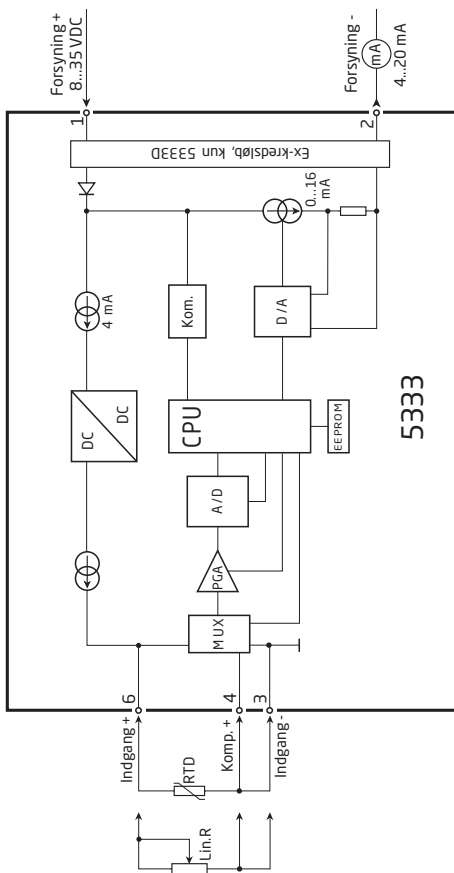

PROGRAMMERING

- Loop Link er et batteridrevet kommunikationsinterface, der er nødvendigt for programmering af PRetop 5333.
- Ved programmering henvises til tegningen nedenfor og hjælpefunktionen i PReset programmet.
- Loop Link må ikke benyttes til kommunikation med moduler installeret i Ex-område.

Bestilling: Loop Link

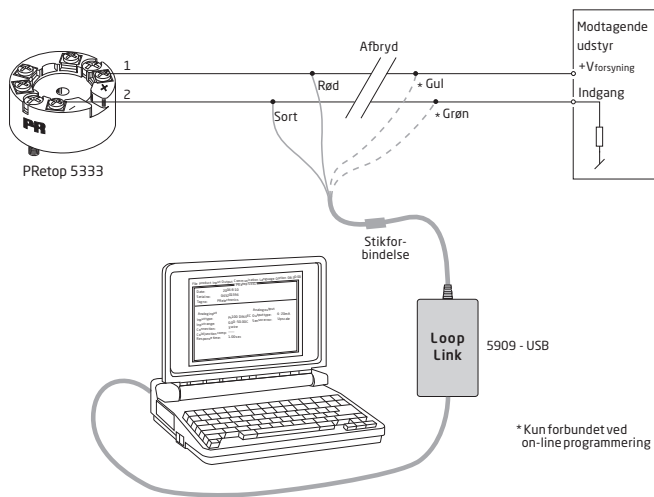

Mekaniske specifikationer

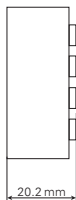
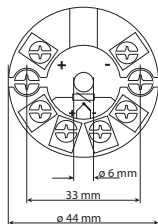

Montering af følerledninger

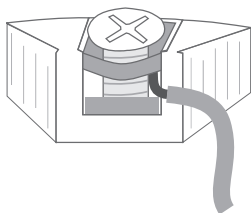

Ledninger monteres mellem metalpladerne

APPENDIX

ATEX Installation Drawing - 5333A

ATEX Installation Drawing - 5333D

IECEx installation drawing - 5333A

IECEx installation drawing - 5333D

FM Installation Drawing - 5333D

CSA Installation Drawing - 5333D

INMETRO Instruções de Segurança - 5333A

INMETRO Instruções de Segurança - 5333D

ATEX Installationstegning

For sikker installation af 5333A skal følgende overholdes: Modulet må kun installeres af kvalificerede personer, som er bekendt med national og international lovgivning, direktiver og standarder i det land, hvor modulet skal installeres.
Produktionsår fremgår af de to første cifre i serienummeret.

ATEX-certifikat KEMA 10ATEX 0003X

Mærkning  II 3 G Ex nA [ic] IIC T4 ... T6 Gc
II 3 G Ex ic IIC T4...T6 Gc
II 3 D Ex ic IIIC Dc

Standarder EN 60079-0 : 2012, EN 60079-11 : 2012, EN 60079-15 : 2010

T4: $-40 \leq T_a \leq 85^{\circ}\text{C}$	Klemme: 3,4,6	Klemme: 1,2	Klemme: 1,2
T6: $-40 \leq T_a \leq 60^{\circ}\text{C}$	Ex nA [ic]	Ex nA	Ex ic
	Uo: 5V	Umax. ≤ 35 VDC	Ui = 35 VDC
	Io: 4,0 mA		Ii = 110mA
	Po: 20 mW		Li = 10 μH
	Lo: 900 mH		Ci = 1,0 nF
	Co: 1000 μF		

Særlige betingelser for sikker anvendelse

Ved beskyttelsestype Ex nA skal transmitteren monteres i et hus med en tæthedegrad på mindst IP54 i overensstemmelse med EN 60529.

Ved installationer i områder med potentiel eksplosionsfare på grund af brændbart støv, skal transmitteren monteres i et hus med en tæthedegrad på mindst IP6X i overensstemmelse med EN 60529. Husets overfladetemperatur er 20 K over omgivelsestemperaturen.

Hvis omgivelsestemperaturen $\geq 60^{\circ}\text{C}$, skal der bruges varmebestandige kabler med specifikationer på mindst 20K over omgivelsestemperaturen.

ATEX Installationstegning



For sikker installation af 5333D skal følgende overholdes: Modulet må kun installeres af kvalificerede personer, som er bekendt med national og international lovgivning, direktiver og standarder i det land, hvor modulet skal installeres.
Produktionsår fremgår af de to første cifre i serienummeret.

ATEX-certifikat KEMA 03ATEX 1535 X

Mærkning  II 1 G Ex ia IIC T4...T6 Ga
II 1 D Ex ia IIIC Da
II 1 M Ex ia I Ma

Standarder EN 60079-0 : 2012, EN 60079-11 : 2012, EN 60079-26 : 2007,
EN 60079-15 : 2010

Ex-område
Zone 0, 1, 2, 20, 21, 22

T4: $-40 \leq T_a \leq 85^\circ\text{C}$
T6: $-40 \leq T_a \leq 60^\circ\text{C}$

Klemme: 3,4,6
Uo: 27 VDC
Io: 7 mA
Po: 45 mW
Lo: 35 mH
Co: 90 nF

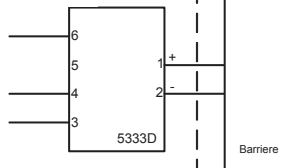

Klemme: 1,2
Ui: 30 VDC
Ii: 120 mA
Pi: 0,84 W
Li: 10 μH
Ci: 1,0 nF

Installationsforskrifter:

I områder med potential eksplosionsfare på grund af brændbar gas skal transmitteren installeres i et hus med en kapslingsklasse på mindst IP20 i overensstemmelse med EN60529.

Hvis transmitteren installeres i eksplosive atmosfærer, hvor kategori 1 G, 1 M eller 2 M udstyr er krævet, og hvis huset er lavet af aluminium, skal det installeres således, at der selv ved sjældent opstående hændelser ikke er risiko for antændelse på grund af stød og friktionsgnister; hvis huset er lavet af ikke-metallisk materiale, skal elektrostatisk ladninger på transmitters hus undgås.

For installation i områder med potentiel eksplosionsfare på grund af brændbart støv skal følgende overholdes:

Transmitteren skal monteres i et form B metalhus i overensstemmelse med DIN 43729. Huset skal have en tæthedegrad på mindst IP 6X i overensstemmelse med EN 60529 og skal være egnet til den pågældende applikation samt være installeret korrekt.

Der må kun anvendes kabelforskrutninger og blindstik, som egner sig til den pågældende applikation og som installeres korrekt.

Hvis omgivelsestemperaturen $\geq 60^{\circ}\text{C}$, skal der bruges varmebestandige kabler med specifikationer på mindst 20K over omgivelsestemperaturen.

Husets overfladetemperatur er lig med den maksimale omgivelsestemperatur plus 20 K for støvlag med en tykkelse på op til 5 mm.

IECEx Installation drawing



For safe installation of 5333A or 5343A the following must be observed. The module shall only be installed by qualified personnel who are familiar with the national and international laws, directives and standards that apply to this area.
Year of manufacture can be taken from the first two digits in the serial number.

Certificate	IECEx DEK 13.0036X	
Marking	Ex nA [ic] IIC T6..T4 Gc	T4: $-40 \leq T_a \leq 85^\circ\text{C}$
	Ex ic IIC T6..T4 Gc	T6: $-40 \leq T_a \leq 60^\circ\text{C}$
	Ex ic IIIC Dc	
Standards	IEC 60079-0 : 2011, IEC 60079-11 : 2011, IEC 60079-15 : 2010	

Terminal	Ex nA [ic]	Ex ic
1,2	$U_{\max} = 35\text{V}$	$U_i : 35\text{V}, I_i : 110\text{mA}, I_i : 10\mu\text{H}, C_i : 1,0\text{nF}$
3,4,6	$U_o : 5\text{V}, I_o : 4\text{mA}, P_o : 20\text{mW}, L_o : 900\text{mH}, C_o : 1000\mu\text{F}$	

Installation note:

For installation in a potentially explosive gas atmosphere, the following instructions apply:

For nA installation the transmitter must be installed in an metal enclosure e.g. a form B enclosure, providing a degree of protection of at least IP54 according to IEC60529 or in an enclosure with type of protection Ex n or Ex e.

For ic installation the transmitter must be installed in enclosure providing a degree of protection of at least IP20 according to IEC60529 and that is suitable for the application.

Cable entry devices and blanking elements shall fulfill the same requirements

For an ambient temperature $\geq 60^\circ\text{C}$, heat resistant cables shall be used with a rating of at least 20 K above the ambient temperature.

For installation in a potentially explosive dust atmosphere, the following instructions apply:

The surface temperature of the enclosure is equal to the ambient temperature plus 20 K, for a dust layer with a thickness up to 5 mm.

The transmitter must be mounted in a enclosure according to DIN 43729 that provides a degree of protection of at least IP6X according to IEC60529, and that is suitable for the application. Cable entry devices and blanking elements shall fulfill the same requirements.

IECEx Installation drawing



For safe installation of 5333D or 5343B the following must be observed. The module shall only be installed by qualified personnel who are familiar with the national and international laws, directives and standards that apply to this area.

Year of manufacture can be taken from the first two digits in the serial number.

Certificate	IECEx DEK 13.0036X
Marking	Ex ia IIC T4...T6 Ga Ex ia IIC Da Ex ia I Ma
Standards	IEC 60079-0 : 2011, IEC 60079-11 : 2011, IEC 60079-26:2006

Hazardous area
Zone 0, 1, 2, 20, 21, 22, M1

T4: $-40 \leq T_a \leq 85^{\circ}\text{C}$

T5: $-40 \leq T_a \leq 60^{\circ}\text{C}$

T6: $-40 \leq T_a \leq 45^{\circ}\text{C}$

Non Hazardous Area

Terminal: 3,4,6

U_o: 30 VDC

I_o: 8 mA

P_o: 60 mW

L_o: 35 mH

C_o: 66 nF

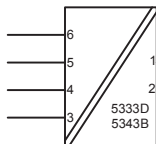

Terminal: 1,2

U_i: 30 VDC

I_i: 120 mA

P_i: 0.84 W

L_i: 10μH

C_i: 1.0nF

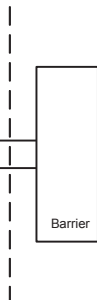

Installation notes.

In a potentially explosive gas atmosphere, the transmitter shall be mounted in a metal form B enclosure in order to provide a degree of protection of at least IP20 according to IEC60529. If however the environment requires a higher degree of protection, this shall be taken into account.

If the transmitter is installed in an explosive atmosphere requiring the use of equipment protection level Ga, Ma and Mb, and if the enclosure is made of aluminum, it must be installed such, that ignition sources due to impact and friction sparks are excluded.

For installation in a potentially explosive dust atmosphere, the following instructions apply:

For explosive dust atmospheres, the surface temperature of the outer enclosure is 20 K above the ambient temperature.

The transmitter shall be mounted in a metal enclosure form B according to DIN43729 that is providing a degree of protection of at least IP6X according to IEC60529, that is suitable for the application and correctly installed.

Cable entries and blanking elements shall be used that are suitable for the application and correctly installed.

For an ambient temperature $\geq 60^{\circ}\text{C}$, heat resistant cables shall be used with a rating of at least 20 K above the ambient temperature.

FM Installation Drawing 5300Q502 Rev AH

Model 5331C, 5331D, 5333C, 5333D and 5343B

Hazardous (Classified) Location

Class I, Division 1, Groups, A, B, C, D
Class I, Zone 0, IIC

Ambient temperature limits
T4: -40 to +85 deg. Celsius
T6: -40 to +60 deg. Celsius

Terminal 1, 2
Vmax or Ui: 30 V
Imax or Ii: 120 mA
Pmax or Pi: 0.84 W
Ci: 1 nF
Li: 10 uH

Terminal 3, 4, 5, 6
Only passive, or non-energy storing devices such as RTD's and Thermocouples may be connected.

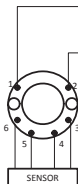

Non Hazardous Location

Associated Apparatus
or Barrier
with
entity Parameters:

$UM \leq 250V$
 $Voc \text{ or } Uo \leq Vmax \text{ or } Ui$
 $Isc \text{ or } Io \leq Imax \text{ or } Ii$
 $Po \leq Pi$
 $Ca \text{ or } Co \geq Ci + Ccable$
 $La \text{ or } Lo \geq Li + Lcable$

This device must not be connected to any associated apparatus which uses or generates more than 250 VRMS

Model 5335C, 5335D, 5336D, 5337D

Hazardous (Classified) Location

Class I, Division 1, Groups, A, B, C, D
Class I, Zone 0, IIC

Ambient temperature limits
T4: -40 to +85 deg. Celsius
T6: -40 to +60 deg. Celsius

Terminal 1, 2
Vmax or Ui: 30 V
Imax or Ii: 120 mA
Pmax or Pi: 0.84 W
Ci: 1 nF
Li: 10 uH

Terminal 3, 4, 5, 6
Vi or Uo: 9.6 V
Ii or Io: 28 mA
Pi or Po: 67.2 mW
Ca or Co: 3.5 uF
La or Lo: 35 mH

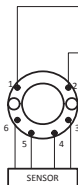

Non Hazardous Location

Associated Apparatus
or Barrier
with
entity Parameters:

$UM \leq 250V$
 $Voc \text{ or } Uo \leq Vmax \text{ or } Ui$
 $Isc \text{ or } Io \leq Imax \text{ or } Ii$
 $Po \leq Pi$
 $Ca \text{ or } Co \geq Ci + Ccable$
 $La \text{ or } Lo \geq Li + Lcable$

This device must not be connected to any associated apparatus which uses or generates more than 250 VRMS

The entity concept

The Transmitter must be installed according to National Electrical Code (ANSI-NFPA 70) and shall be installed with the enclosure, mounting, and spacing segregation requirement of the ultimate application.

Equipment that is FM-approved for intrinsic safety may be connected to barriers based on the ENTITY CONCEPT. This concept permits interconnection of approved transmitters, meters and other devices in combinations which have not been specifically examined by FM, provided that the agency's criteria are met. The combination is then intrinsically safe, if the entity concept is acceptable to the authority having jurisdiction over the installation.

The entity concept criteria are as follows:

The intrinsically safe devices, other than barriers, must not be a source of power.

The maximum voltage $U_i(V_{MAX})$ and current $I_i(I_{MAX})$, and maximum power $P_i(P_{MAX})$, which the device can receive and remain intrinsically safe, must be equal to or greater than the voltage (U_o or V_{OC} or V_i) and current (I_o or I_{SC} or I_i) and the power P_o which can be delivered by the barrier.

The sum of the maximum unprotected capacitance (C_i) for each intrinsically device and the interconnecting wiring must be less than the capacitance (C_a) which can be safely connected to the barrier.

The sum of the maximum unprotected inductance (L_i) for each intrinsically device and the interconnecting wiring must be less than the inductance (L_a) which can be safely connected to the barrier.

The entity parameters U_o, V_{OC} or V_i and I_o, I_{SC} or I_i , and C_a and L_a for barriers are provided by the barrier manufacturer.

NI Field Circuit Parameters

Model 5331C, 5331D, 5333C, 5333D, 5335C, 5335D, 5336D, 5337D and 5343B

Hazardous (Classified) Location

Class I, Division 2, Groups, A, B, C, D
Class I, Zone 2, IIC

Ambient temperature limits
T4: -40 to +85 deg. Celcius
T6: -40 to +60 deg. Celcius

Terminal 1, 2
 V_{max} : 35 V
 C_i : 0 μ F
 L_i : 10 μ H

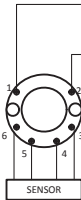

Non Hazardous Location

Associated Apparatus
or Barrier

This device must not be connected to any associated apparatus which uses or generates more than 250 VRMS

CSA Installation drawing 533XQC03

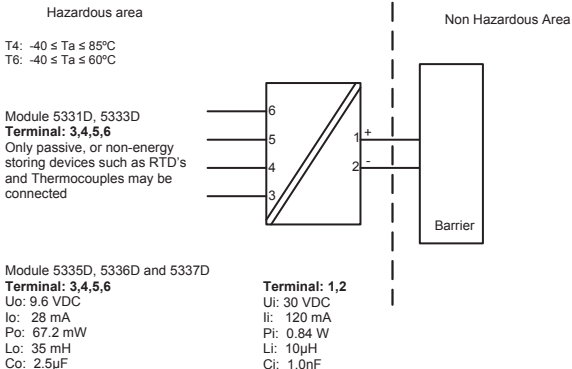

CLASS 2258 04 - PROCESS CONTROL EQUIPMENT - Intrinsically Safe Entity - For Hazardous Locations
Class I, Division 1, Groups A, B, C and D
Ex ia IIC, Ga

CLASS 2258 84 - PROCESS CONTROL EQUIPMENT - Intrinsically Safe Entity - For Hazardous Locations - Certified to US Standards
Class I, Division 1, Groups A, B, C and D
Class I, Zone 0, AEx ia IIC, Ga

Warning:

Substitution of components may impair intrinsic safety.

The transmitters must be installed in a suitable enclosure to meet installation codes stipulated in the Canadian Electrical Code (CEC) or for US the National Electrical Code (NEC).

Desenho de Instalação InMETRO



Para instalação segura do 5333A ou 5343A o seguinte deve ser observado. O modo deve apenas ser instalado por pessoas qualificadas que são familiarizadas com as leis nacionais e internacionais, diretrizes e padrões que se aplicam a esta área.
 Ano de fabricação pode ser pego dos dois primeiros dígitos do número de série.

Certificado	IECEX DEK 13.0002 X	
Indicação	Ex nA [ic] IIC T6..T4 Gc	T4: $-40 \leq Ta \leq 85^{\circ}\text{C}$
	Ex ic IIC T6..T4 Gc	T6: $-40 \leq Ta \leq 60^{\circ}\text{C}$
	Ex ic IIIC Dc	

Padrões ABNT NBR IEC 60079-0 : 2008, ABNT NBR IEC 60079-11 : 2009,
 IEC 60079-15 : 2010, ABNT NBR IEC 60079-26 : 2008

Terminal	Ex nA [ic]	Ex ic
1,2	U _{max} = 35V	Ui : 35V, li:110mA, li:10μH, Ci:1,0nF
3,4,6	Uo: 5V, Io: 4mA, Po: 20mW, Lo: 900mH, Co: 1000μF	

Notas para instalação

Para a instalação em uma atmosfera de gás potencialmente explosivo, se aplicam as instruções a seguir:

Para a instalação nA o transmissor deve ser instalado em um gabinete de metal, por exemplo, gabinete em forma B que forneça um grau de proteção de pelo menos IP54 de acordo com IEC60529 ou em uma caixa com tipo de proteção Ex n ou Ex e.

Para a instalação iC o transmissor deve ser instalado em um invólucro proporcionando um grau de proteção de IP20, pelo menos, de acordo com a norma IEC60529 que é adequado para a aplicação.

Dispositivos de entrada de cabos e elementos de supressão devem cumprir os mesmos requisitos.

Para uma temperatura ambiente $\geq 60^{\circ}\text{C}$, os cabos resistentes ao calor precisam ser utilizados com uma classificação de pelo menos 20 K acima da temperatura ambiente.

Para a instalação em uma atmosfera de poeira potencialmente explosiva, se aplicam as instruções a seguir:

A temperatura da superfície do invólucro é igual à temperatura ambiente mais 20 K, para uma camada de pó, com uma espessura superior a 5 mm.

O transmissor deve ser montado em um invólucro de acordo com a norma DIN 43729, que proporciona um grau de proteção de, pelo menos, IP6X de acordo com a norma IEC60529, e que seja apropriado para a aplicação.

Dispositivos de entrada de cabos e elementos de supressão devem cumprir as mesmas exigências

Desenho de Instalação InNMETRO



Para instalação segura do 5333D ou 5343B o seguinte deve ser observado. O modo deve apenas ser instalado por pessoas qualificadas que são familiarizadas com as leis nacionais e internacionais, diretrizes e padrões que se aplicam a esta área.
Ano de fabricação pode ser pego dos dois primeiros dígitos do número de série.

Certificado	DEKRA 13.0002 X
Indicação	Ex ia IIC T6...T4 Ga Ex ia IIIC Da
Padrões	ABNT NBR IEC 60079-0 : 2008, ABNT NBR IEC 60079-11 : 2009, IEC 60079-15 : 2010, ABNT NBR IEC 60079-26 : 2008

Áreas perigosas

Zona 0, 1, 2, 20, 21, 22, M1

T4: $-40 \leq T_a \leq 85^\circ\text{C}$

T5: $-40 \leq T_a \leq 60^\circ\text{C}$

T6: $-40 \leq T_a \leq 45^\circ\text{C}$

Sem áreas perigosas

Terminal: 3,4,5,6

Uo: 30 VDC

Io: 8 mA

Po: 60 mW

Lo: 35 mH

Co: 66 nF

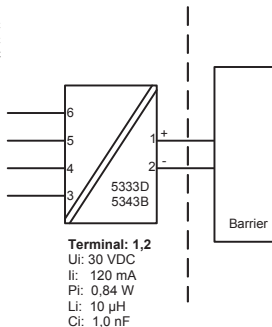

Notas de Instalação.

Em uma atmosfera de gás potencialmente explosiva, o transmissor deve ser montado em um enclosure a fim de garantir um grau de proteção de no mínimo IP20 de acordo com EN60529. Se contudo o ambiente requer um nível de proteção maior, isso deve ser levado em conta

Se o transmissor é instalado em uma atmosfera explosiva exigindo o uso de equipamento de categoria Ga e se o enclosure é feito de alumínio, ele deve ser instalado de modo que, mesmo em caso de avaria rara, fontes de ignição devido a impacto e fricção, faíscas são eliminadas; se o enclosure é feito de materiais não metálicos, cargas eletroestáticas devem ser evitadas.

Para instalação em atmosfera de poeira potencialmente explosiva, as instruções a seguir:

O transmissor deve ser montado em enclosure de metal forma B de acordo com DIN43729 que está fornecendo um grau de proteção de pelo menos IP6X de acordo com EN60529. Isso é adequado para aplicação e corretamente instalado.

As entradas dos cabos e os elementos de obturação que podem ser utilizados são adequados para a aplicação e corretamente instalados.

Para temperatura ambiente $\geq 60^{\circ}\text{C}$, fios de resistência ao calor devem ser usados com uma faixa de pelo menos 20K acima da temperatura ambiente.

A temperatura da superfície do enclosure é igual à temperatura ambiente mais de 20 K, por uma camada de pó, com uma espessura até 5 mm.



Displays Programmable displays with a wide selection of inputs and outputs for display of temperature, volume and weight, etc. Feature linearisation, scaling, and difference measurement functions for programming via PReset software.



Ex interfaces Interfaces for analogue and digital signals as well as HART® signals between sensors / I/P converters / frequency signals and control systems in Ex zone 0, 1 & 2 and for some devices in zone 20, 21 & 22.



Isolation Galvanic isolators for analogue and digital signals as well as HART® signals. A wide product range with both loop-powered and universal isolators featuring linearisation, inversion, and scaling of output signals.

























Temperature A wide selection of transmitters for DIN form B mounting and DIN rail devices with analogue and digital bus communication ranging from application-specific to universal transmitters.



Universal PC or front programmable devices with universal options for input, output and supply. This range offers a number of advanced features such as process calibration, linearisation and auto-diagnosis.



- 
 www.preelectronics.fr
 sales-fr@preelectronics.com
- 
 www.preelectronics.de
 sales-de@preelectronics.com
- 
 www.preelectronics.es
 sales-es@preelectronics.com
- 
 www.preelectronics.it
 sales-it@preelectronics.com
- 
 www.preelectronics.se
 sales-se@preelectronics.com
- 
 www.preelectronics.co.uk
 sales-uk@preelectronics.com
- 
 www.preelectronics.com
 sales-us@preelectronics.com
- 
 www.preelectronics.cn
 sales-cn@preelectronics.com

Head office

Denmark
 PR electronics A/S
 Lerbakken 10
 DK-8410 Rønde

www.preelectronics.com
sales-dk@preelectronics.com
 tel. +45 86 37 26 77
 fax +45 86 37 30 85



QUALITY SYSTEM AND ENVIRONMENTAL MANAGEMENT SYSTEM
 DS/EN ISO 9001
 DS/EN ISO 14001

